



Product name:
Product number:

Double Ended SP9 Reaction Arm Blank
34771

REV: 12-2024

All dimensions are in Inches [Millimeters]

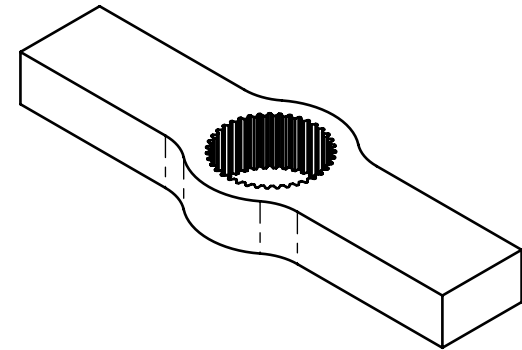
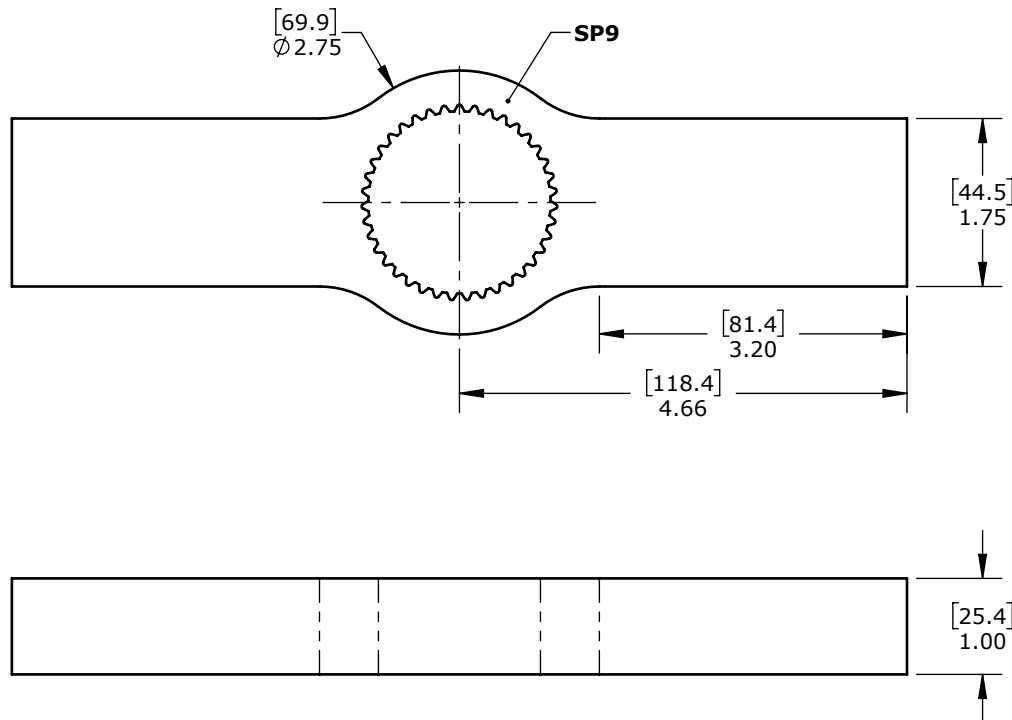

Suitable for: 1800NGX-R, 2400NGX-R

DISCLAIMER: The data and illustrations in this document are accurate to the best of the company's knowledge. Information is subject to change without prior notice. For critical information, please verify its accuracy by contacting RAD Torque Systems. Unauthorized reproduction and distribution of this content are strictly prohibited.